

Lattice™

● Lattice™ Trapezium
in Ironbank

● Morgan Lovell,
New Zealand



Sculptural functionality

Delightfully abstract, yet calculated in form, Lattice™ is a range of hanging sculptures built from a grid of acoustic fins. With each intersection, Lattice covers a greater surface area than traditional parallel fin systems—effectively absorbing echo and reverberation in interior spaces.

The Lattice range offers three standard designs, each suited to a variety of applications. Made from 100% polyester fiber, Lattice is lightweight and structurally sound—designed to hold shape throughout its lifetime.

To find out more about Lattice
visit www.autexglobal.com

● Lattice Eclipse in Pinnacle, Falling Water,
Ironbank and Flatiron

● The Remarkables,
New Zealand





Features and benefits

- Delivers excellent acoustic performance
- Covers a greater surface area than traditional parallel fin systems for optimum acoustic absorption
- Available in 23 colors with three styles
- Easily customizable

Applications

- Decorative and functional acoustic treatment for interior spaces
- Can be suspended or direct fixed to ceilings



Design options

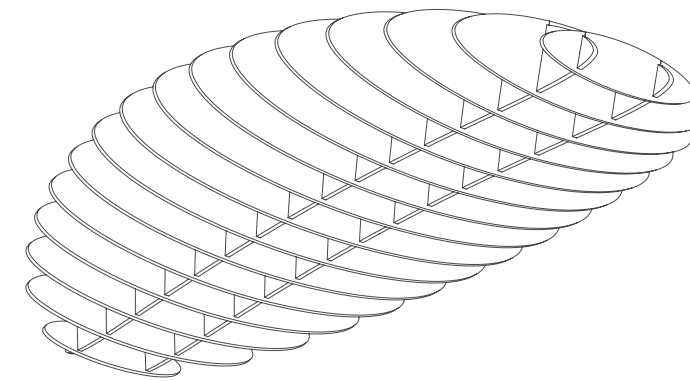

Eclipse

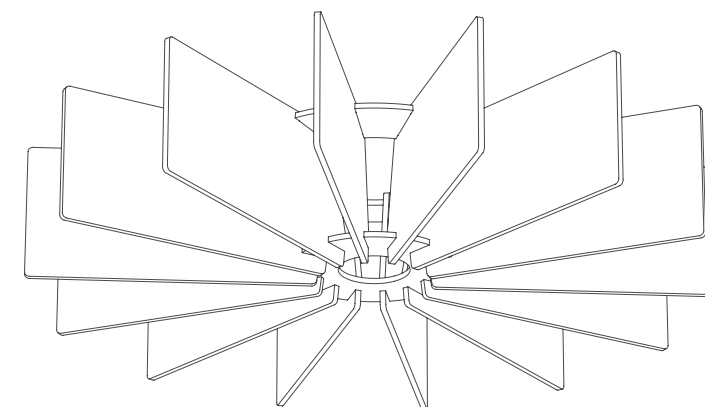

Torus

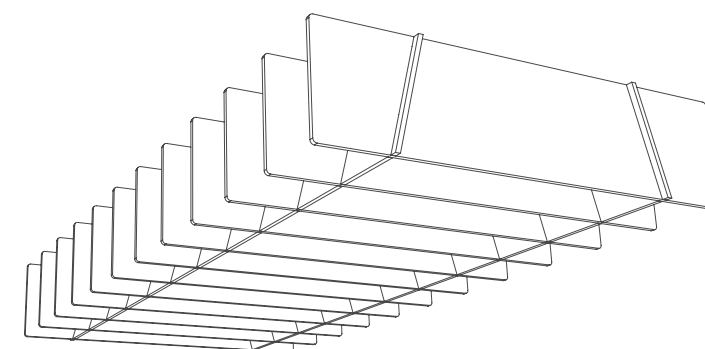

Trapezium

Color options

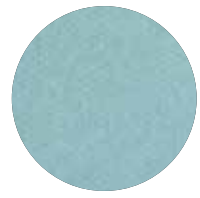

Falling Water

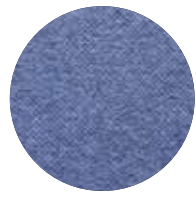

Galaxy

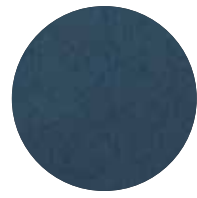

Pinnacle

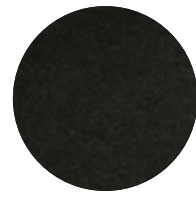

Petronas

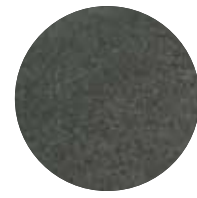

Empire

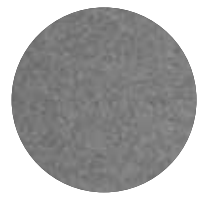

Flatiron

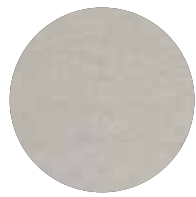

Savoye

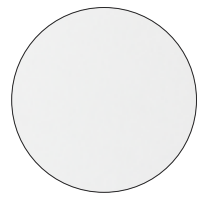

Pavilion

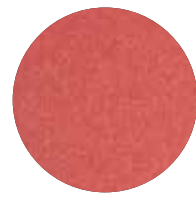

Ironbank

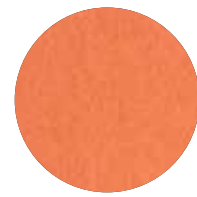

Zenith

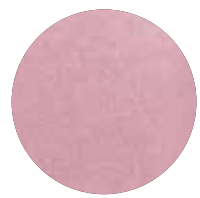

Rosada

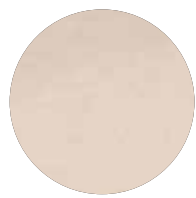

Opera

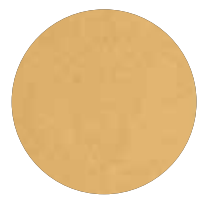

Senado



Acros

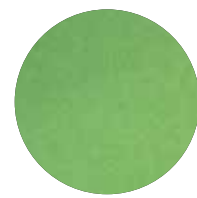

Bosco



Lotus



Tree House



Gherkin



Muralla

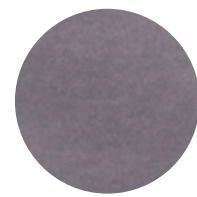

Cavalier

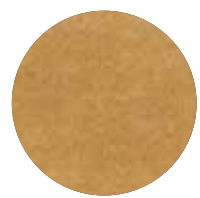

Beehive



Parthenon



Sargazo

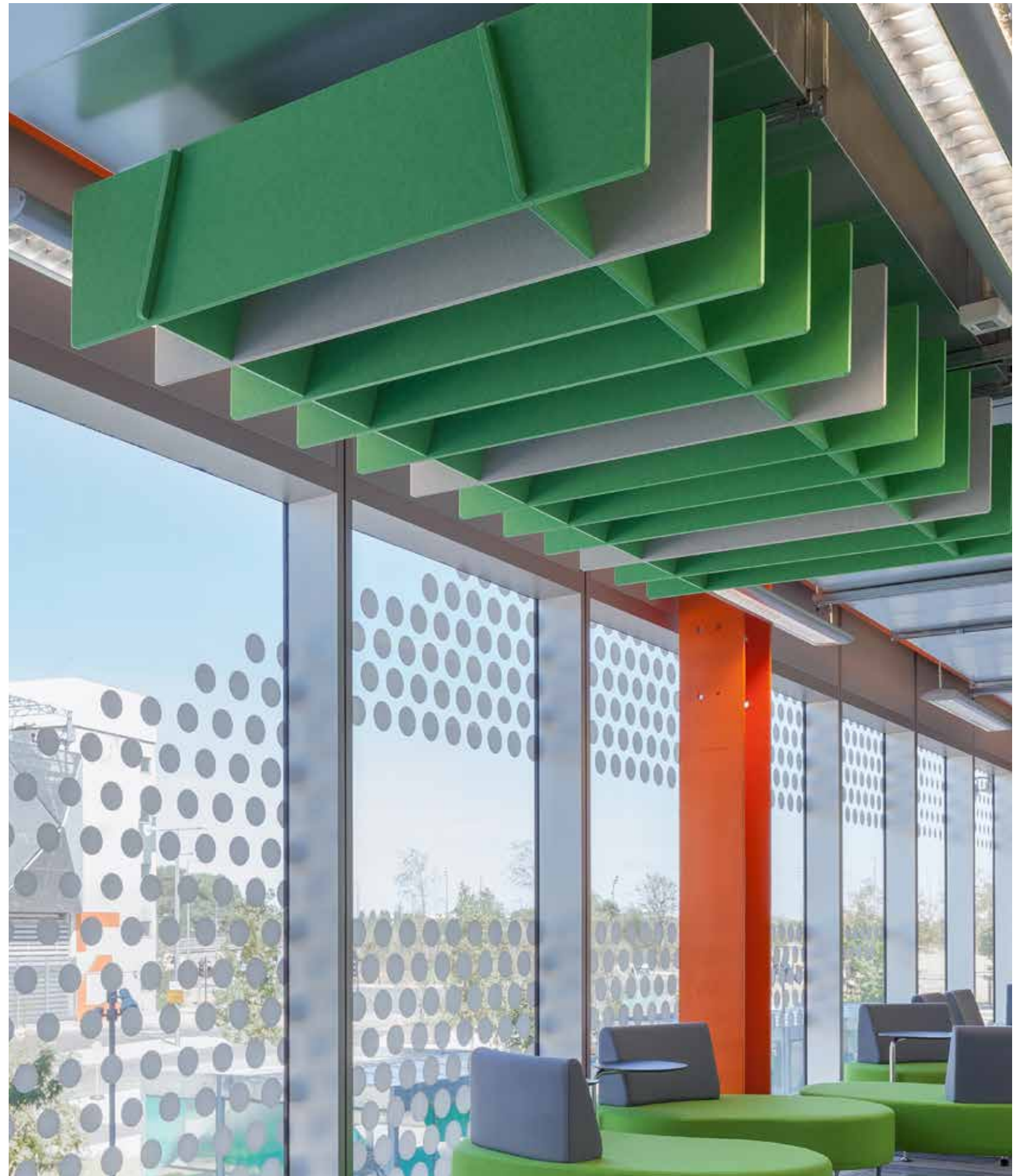



Caring for the environment

Lattice is manufactured using 100% polyester fiber and contains a minimum of 60% recycled fiber (from PET plastics). Our products are designed to be recycled at the end of their life too.

We have continual improvement programmes in which we implement a range of initiatives to mitigate the environmental 'hotspots' that we have identified. Our products are GreenRate Level A, Health Product Declaration (HPD), and CDHP Standard certified.

Lattice is made from Cube which is DeclareSM certified to be Red List free and can be used in Living Building Challenge projects. Autex has a high functioning Environmental Management System (ISO 14001) to enhance our environmental performance and contribute to sustainable development.



Declare.



● **Autex Industries Ltd**

702-718 Rosebank Rd
Private Bag 19988
Avondale 1746, Auckland
New Zealand
Freephone 0800 428 839
Phone +64 9 828 9179
Fax +64 9 828 5810

● **Autex Australia Pty Ltd**

166 Bamfield Road
PO Box 5099
West Heidelberg, Melbourne
VIC 3081, Australia
Freephone 1800 678 160
Phone +61 3 9457 6700
Fax +61 3 9457 1020

● **Autex Acoustics Ltd**

Unit J4, Lowfields Way,
Lowfields Business Park,
Elland, West Yorkshire
Hx5 9Da
United Kingdom
Phone +44 0 1422418899

● **Autex Acoustics LLC**

1630 Dan Kipper Dr,
Riverside, CA 92507
United States of America
Phone +1 424 203 1813

An ISO 9001, ISO 14001 and ISO 45001 certified company. The brand names and logos mentioned herein are registered or unregistered trademarks either owned or used under license by Autex Industries Limited or other members of the Autex Group. The contents of this document are protected by Copyright 2021 Autex Industries Ltd. All Rights Reserved. It is the user's responsibility to determine if the product and information presented in this document is suitable for the intended application by engaging a suitably qualified consultant. The information contained in this document is correct to the best of our knowledge at the date of its publication. To verify that this document is the most current publication please check our website or contact your Autex account manager.